

Article number: 0110084

Description: Retaining ring JS 75x3
Springsteel

Measures

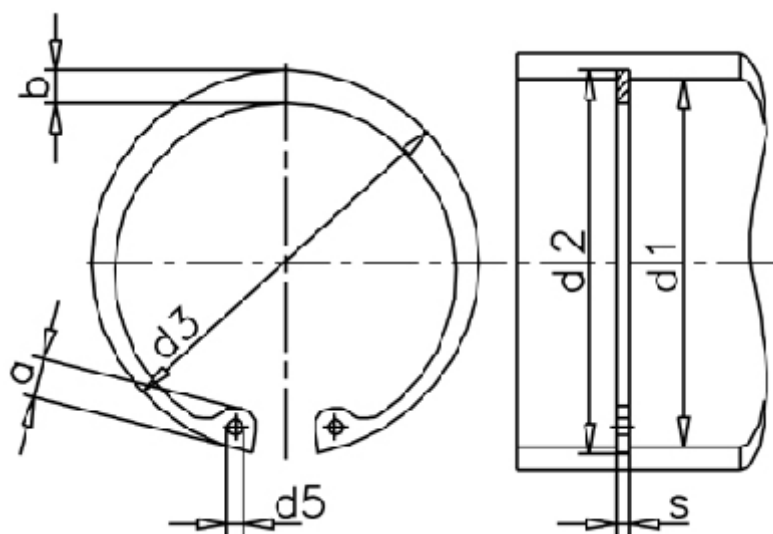

a max	= 9.3	Description	= JS 75	t	= 1.50
AN mm ²	= 360	FN kN	= 60.0	tol	= 0.30
B	= 1.44	FRg kN	= 30.3	tol	= +1,10 -0,46
b	= 6.6	FR kN	= 170.0	tol	= -0.08
d1	= 75	g	= 2.5	Tong	= ZGJ-3
d2	= 78.0	m min	= 3.15	Weight kg/1000	= 22.6
d3	= 79.5	Nominal drive	= 4.5		
d5 min	= 3.0	s	= 3.00		